

MT32 Telemetry

Multi channel telemetry system for rotating application

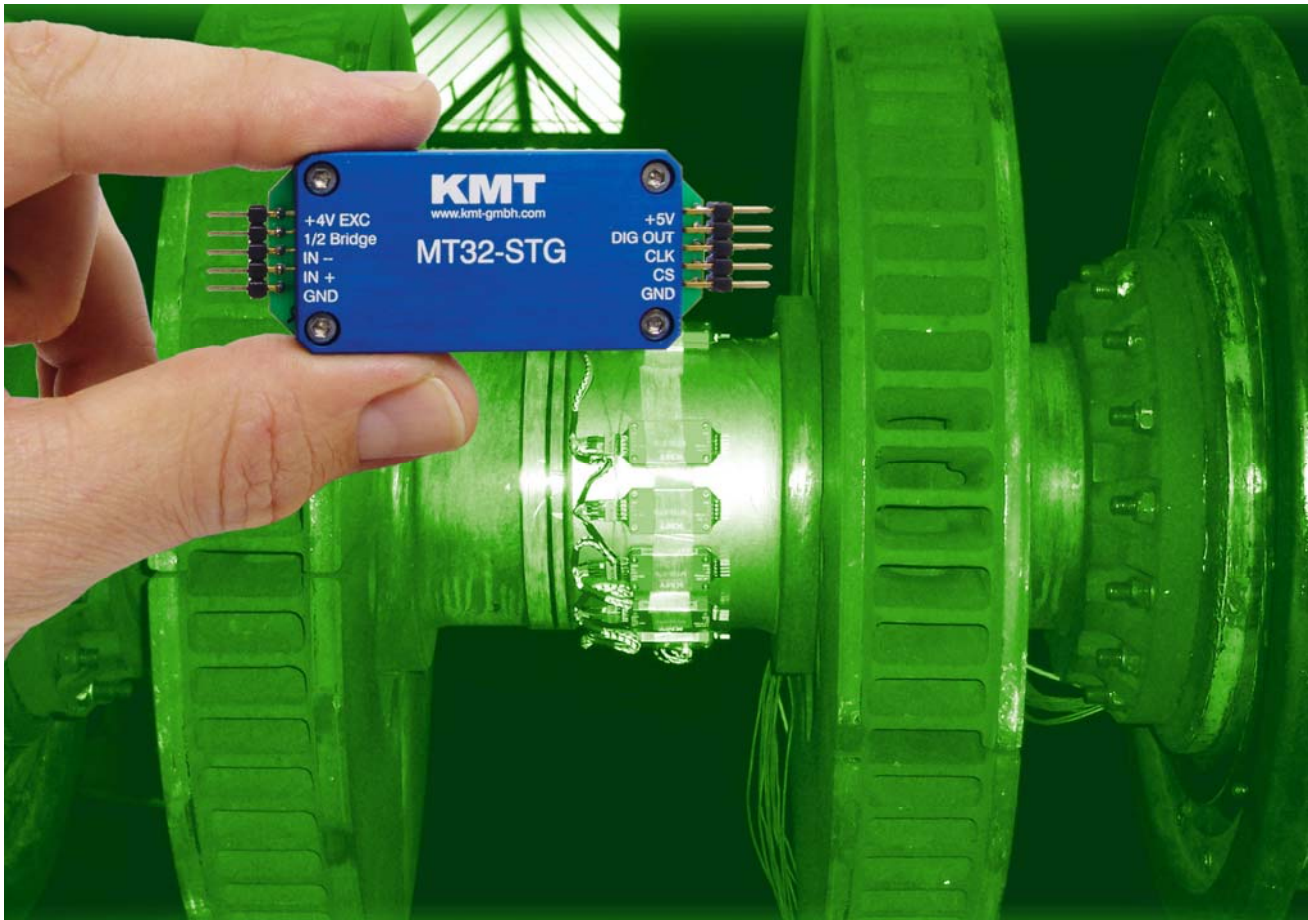

- Up to 32 channel
- Sensor inputs for STG, POT, TH-K, Pt100, 4-20mV, ICP or VOLT
- STG - Auto Zero calibration
- Anti aliasing filters
- 12 bit ADC resolution
- Signal bandwidth up to 0...24000Hz
- Powering (rotor) by battery or inductive
- Digital inductive or radio transmission
- Distance up to 10m (Radio Tx)
- Easy to assemble and operate
- Output +/-5V add. 4-20mA (Option)
- System accuracy <0.25%
- Digital PCM interface for PC

Short description:

The MT32 Mini-Telemetry is a very small and flexible telemetry system for rotating, mobile and stationary applications. Each sensor module is equipped with signal conditioning, anti-aliasing filters, analog-to-digital converters and a digital output. All these up to 32 modules will be controlled by an encoder (multiplexer with PCM output) module. By this concept it's possible to install the acquisition modules close to the sensor to have short connections for the analog sensor lines. This avoids an undesired coupling of disturbances resulting in noisy signals. The interference insensitive digital outputs then can lead over wider distances of up to 1m to the encoder module. The encoder output is a PCM bit stream signal which can be modulated for emission by a transmitter module for a distance of up to 10m. Suitable for wireless data transmission rates of 40kbit/s up to 2560kbit/s.

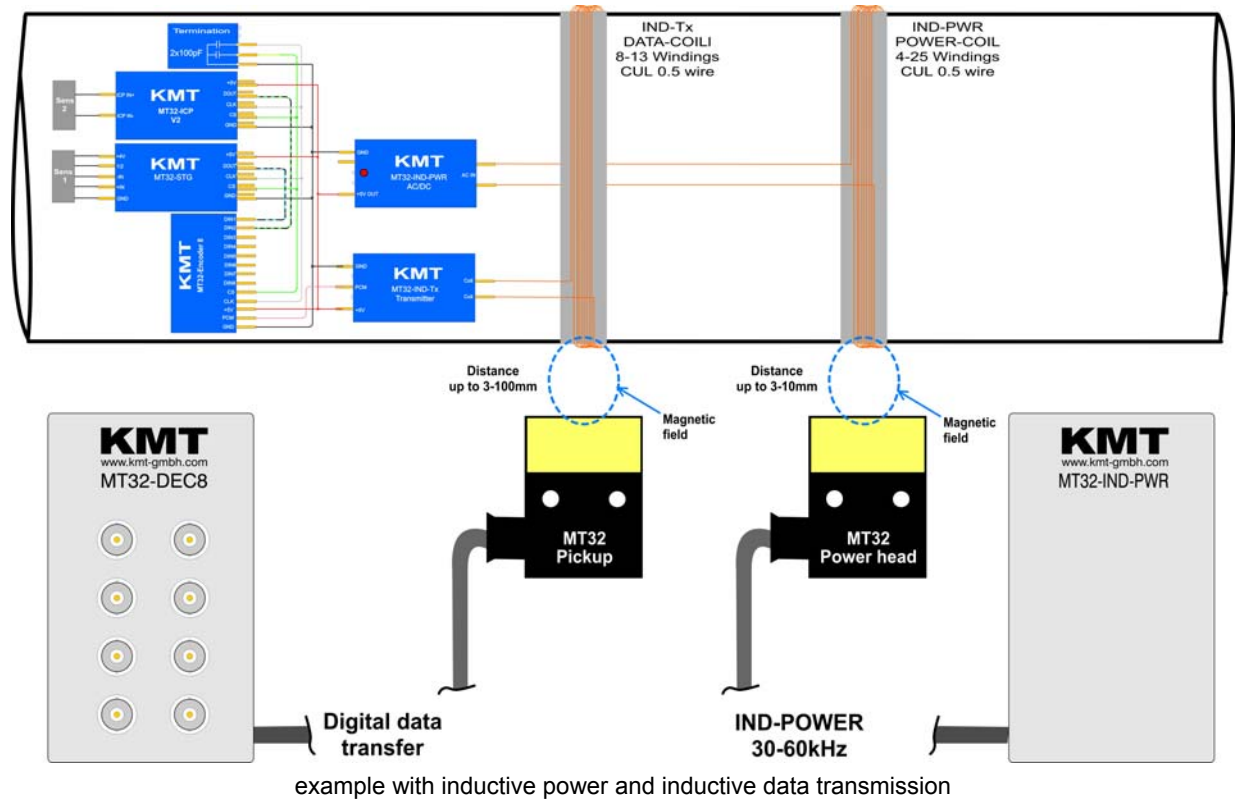



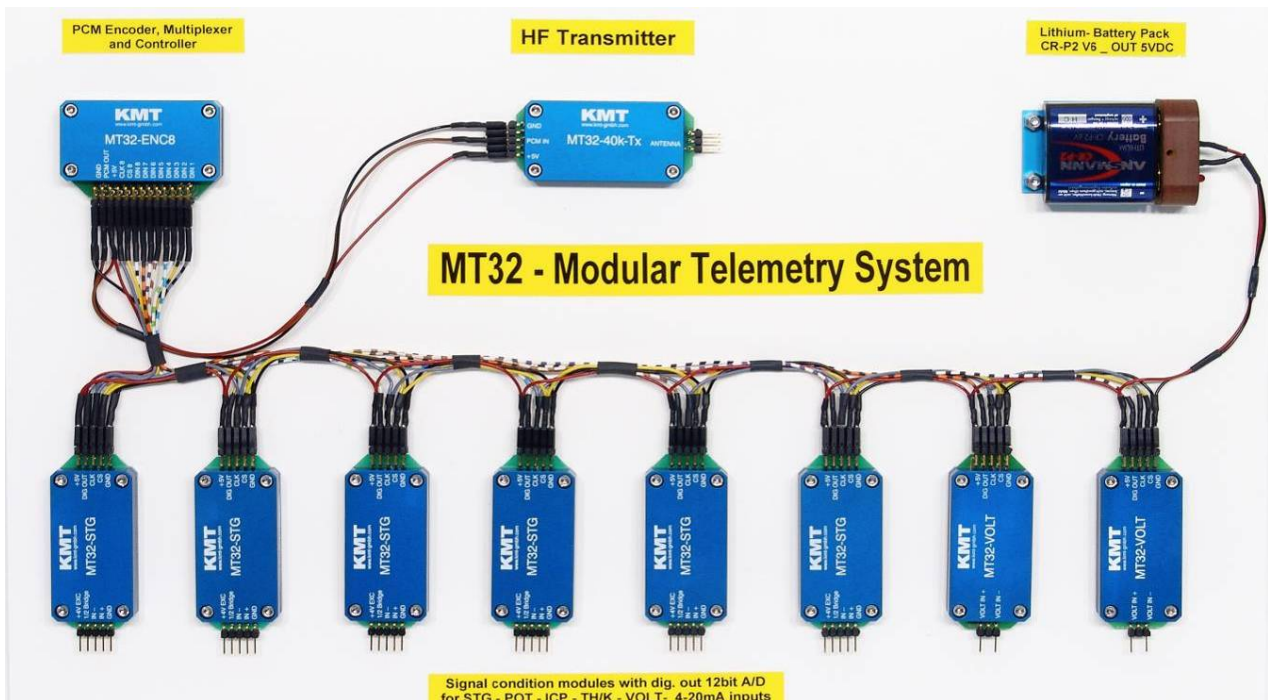







example with inductive power and inductive data transmission



Signal condition modules with dig. out 12bit A/D for STG - POT - ICP - TH/K - VOLT. 4-20mA inputs

example with 8-channels (rotation part)

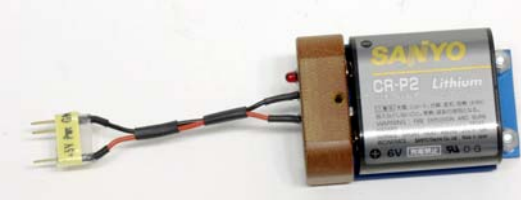
MT32 acquisition modules

 <p style="text-align: center;">52 x 27 x 11 mm Weight 20 grams</p>	<p>MT32-STG V1 For strain gages Full and half ($\geq 350\Omega$) (quarter bridge only with external completions resistor!) Fixed excitation 4V DC Offset calibration via potentiometer or optional auto-zeroing Gain 200 or 1000 Anti aliasing filter Resolution 12bit = 72dB dynamic range Accuracy <0.25% Consumption of current: 20mA</p>	 <p style="text-align: center;">52 x 27 x 11 mm Weight 20 grams</p>	<p>MT32-POT For all potentiometer values 350Ohm to 10kOhm Excitation: 4 VDC (fixed) Resolution 12bit = 72dB dynamic range Anti aliasing filter Accuracy <0.25% Consumption of current: 20mA</p>
 <p style="text-align: center;">52 x 27 x 11 mm Weight 20 grams</p>	<p>MT32-STG V2 For strain gages Full and half ($\geq 350\Omega$) (quarter bridge only with external completions resistor!) Fixed excitation 4V DC Offset calibration via potentiometer or optional auto-zeroing Gain: 250-500-1000-2000 or 1000-2000-4000-8000 Specify at order Anti aliasing filter Resolution 12bit = 72dB dynamic range Accuracy <0.25% Consumption of current: 26mA</p>	 <p style="text-align: center;">52 x 27 x 11 mm Weight 20 grams</p>	<p>MT32-PT100 For thermo resistors Range -100 ... +500 °C Resolution 12bit = 72dB dynamic range Accuracy <0.5% Consumption of current: 5mA</p>
 <p style="text-align: center;">52 x 27 x 11 mm Weight 20 grams</p>	<p>MT32-ICP For ICP® sensor inputs Current exc. 4mA (optional 1mA) Signal gain x 2, 4, 8, 16 and 32 (optional x 1, 2, 4, 8 and 16) Signal bandwidth 3 Hz up to 12000Hz* (*dependent of the max. cut of frequency) Resolution 12bit = 72dB dynamic range Accuracy <0.25% Consumption of current: 50mA</p>	 <p style="text-align: center;">52 x 27 x 11 mm Weight 20 grams</p>	<p>MT32-VOLT For high level inputs $\pm 5V$ or $\pm 10V$ Resolution 12bit = 72dB dynamic range Accuracy <0.25% Consumption of current: 10mA Optional with galvanic isolation!</p>
 <p style="text-align: center;">52 x 27 x 11 mm Weight 20 grams</p>	<p>MT32-TH K-ISO For thermo couples type K (with galvanic isolation!) Range -50 to 1000 °C (other range on request) Resolution 12bit = 72dB dynamic range Bandwidth 0-20Hz Accuracy <1% Consumption of current: 12mA</p>		
MT32 power supply rotating part			
 <p style="text-align: center;">52 x 27 x 11 mm Weight 20 grams</p>	<p>DC/DC PWR-5V-1000 Input 7...30V DC Output 5V DC Max. current 1000mA</p>		<p>Lithium battery from SAFT: 2x LSH14, 3.6V each, 5800mAh 2x 3.6V = 7.2V with 5800mAh or 2x LSH20, 3.6V each, 13000mAh 2x 3.6V = 7.2V with 13000mAh</p> <p style="color: red; font-weight: bold;">This is only a recommendation! The use of lithium batteries follow at one's own risk!!</p>
 <p style="text-align: center;">58 x 35 x 21 mm Weight about 60gram</p>	<p>MT32-BATT-PACK Input 6V via Lithium battery CR-P2 6V 1500mA/h Output 5V DC Low BATT LED display Max. current 300mA</p> <p style="color: red; font-weight: bold;">This is only a recommendation! The use of lithium batteries follow at one's own risk!!</p>		
 <p style="text-align: center;">52 x 27 x 11 mm Weight 20 grams</p>	<p>MT32- inductive AC/DC PWR 5V Input AC 20-30kHz Output 5V DC Max. current 500mA</p>		<p style="color: blue; font-weight: bold;">For inductive IND-PWR AC/DC module is an additional power supply necessary!</p>

MT32 encoder and decoder



52 x 27 x 11 mm
Weight 20 grams

MT32-ENC8
PCM encoder module for linking the data of up to 8 SC modules to one PCM bit stream for transmission
Consumption of current: 20mA



65 x 105 x 230 mm - Weight 1000 grams

MT32-DEC8
Receiver for up to 2, 4 or 8 channels
±5V output range on female BNC
Total system accuracy ±0,25% without sensors
Powering 10–30V DC or optional 110-230V AC (50Hz-60Hz) with AC/DC adaptor



52 x 27 x 11 mm
Weight 20 grams

MT32-ENC16
PCM encoder module for linking the data of up to 16 SC modules to one PCM bit stream for transmission.
Consumption of current: 20mA



MT32-DEC16
65 x 105 x 230 mm
Weight 1000 grams



Option :BNC16

MT32-DEC16
Receiver for 16 channels
±5V output range
Output 37pol. Sub D
Total system accuracy ±0,25% without sensors
Powering 10–30V DC or optional 110-230V AC with AC/DC adaptor

Option: BNC16, adaptor Box
37 Sub-D to 16 x BNC Outputs

MT32 transmitter module



52 x 27 x 11 mm
Weight 20 grams

MT32-IND-Tx-2560k
Inductive data transmission transmitter
Total sampling rate 160 kS/s
Transmission rate 2560kbit/s
Distance up to 0.1m (>100mm)
Consumption of current: 15mA



52 x 27 x 11 mm
Weight 23 grams

MT32-40k (320-640-1280k available)
Range 10m on rotating applications.
Total scanning rate 2,5 kS/s
Transmission rate 40kbit/s
Transmission power 10mW
Consumption of current: 40mA



52 x 27 x 11 mm
Weight 25 grams

MT32-IND-Tx-45MHz-2560k
Inductive data transmission transmitter with 45MHz carrier (for noise environmental areas!)
Total sampling rate 160 kS/s
Transmission rate 2560kbit/s
Distance up to 0.1m (>100mm)
Consumption of current: 70mA

Cut off frequency from anti-aliasing filter (-3dB) and scanning rate (red)

Bit rate	2 Channels	4 Channels	8 Channels	16 Channels	32 Channels
2560 kbit/s	24000Hz (91428 Hz)	12000 Hz (49231 Hz)	6000 Hz (25600 Hz)	3000 Hz (13061Hz)	1500 Hz (6598Hz)
1280 kbit/s	12000 Hz (45714 Hz)	6000 Hz (24615 Hz)	3000 Hz (12800 Hz)	1500 Hz (6530 Hz)	750 Hz (3298 Hz)
640 kbit/s	6000 Hz (22857Hz)	3000 Hz (12308 Hz)	1500 Hz (6400 Hz)	750 Hz (3265 Hz)	375 Hz (1649 Hz)
320 kbit/s	3000 Hz (11428 Hz)	1500 Hz (6154 Hz)	750 Hz (3200 Hz)	375 Hz (1632 Hz)	190 Hz (824 Hz)
40 kbit/s	375 Hz (1428 Hz)	190 Hz (770 Hz)	95 Hz (400 Hz)	47 Hz (204 Hz)	23 Hz (103 Hz)

Scanning rate, signal bandwidth and frame length depending on bit rate and number of channels

Frame example with 8 channels as following: 8Ch x12 bit = 96 bit + 4 bit sync. = 100 bit

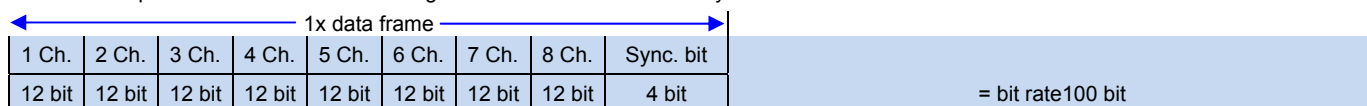

- 32 Ch. x 12 bit = 384 bit + 4 bit sync. = 388 bit
- 16 Ch. x 12 bit = 192 bit + 4 bit sync. = 196 bit
- 8 Ch. x 12 bit = 96 bit + 4 bit sync. = 100 bit
- 4 Ch. x 12 bit = 48 bit + 4 bit sync. = 52 bit
- 2 Ch. x 12 bit = 24 bit + 4 bit sync. = 28 bit

Scanning you can calculate e.g.: 40kbit transfer rate, 8 Ch. = 40000 : 100bit = 400Hz per Ch.

Environmental:

Rotating Part (blue modules):



- Operating Temperature -20 – +80°C
- Storage Temperature..... -30 – +90°C
- Humidity (non-condensing)..... 20 – 80%
- Vibration 5g Mil standard 810C, curve C
- Shock & static acceleration (in any direction)..... 3000g

Down load formula (Excel format) to calculate the static acceleration (RPM/diameter):

[http://www.kmt-gmbh.com/en/telemetrie/Calculation of radial acceleration of shaft.xls](http://www.kmt-gmbh.com/en/telemetrie/Calculation%20of%20radial%20acceleration%20of%20shaft.xls)

Receiving Part:



- Operating Temperature -10 – +70°C
- Storage Temperature..... -20 – +80°C
- Humidity (non-condensing)..... 20 – 80%
- Vibration 5g Mil standard 810C, curve C
- Shock (in any direction) 100g

Application

Streetcar wheel	Railway wheel	Railway wheel	Railway wheel
Belt disk of car	Drive shaft of ship engines	Shaft of wind power plant	Test rigs
Drive shaft of wheel loader	Force measurements	24kHz data transmission TTL	Special solution for force test at milling machine

Item	Qty.	Type	Description
8a			Order Samples
			MT32-2CH-40k, 2xSTG, BATT, BW 2x0-375Hz
	2	MT32-STG	Signal conditioning module for strain gages with digital data acquisition
	1	MT32-ENC8	Encoder for up to 8 acquisition module
	1	MT32-40k-10	ISM-Band telemetry transmitter and receiver (distance up to 0.5 to 10m)
	1	BATT-PACK	Battery pack
	1	BATT-SET	Battery set
	1	MT32-DEC2	Decoder for 2 channels, Output 2 x BNC
	1	AC/DC	AC/DC power supply for DEC2 (Optional)
			MT32-2CH-IND-TX-RX, 2xSTG, BATT, BW 2x0-24000Hz
	2	MT32-STG	Signal conditioning module for strain gages with digital data acquisition
	1	MT32-ENC8	Encoder for up to 8 acquisition module
	1	MT32-IND-RX-TX	Inductive telemetry 2560kbit transmitter and receiver (distance 0.1m)
	1	BATT-PACK	Battery pack
	1	BATT-SET	Battery set
	1	MT32-DEC2	Decoder for 2 channels, Output 2 x BNC
	1	AC/DC	AC/DC power supply for DEC2 (Optional)
			MT32-4CH-40k, 4xSTG, BATT, BW 4x0-190Hz
	4	MT32-STG	Signal conditioning module for strain gages with digital data acquisition
	1	MT32-ENC8	Encoder for up to 8 acquisition module
	1	MT32-40k-10	ISM-Band telemetry transmitter and receiver (distance up to 0.5 to 10m)
	1	BATT-PACK	Battery pack
	1	BATT-SET	Battery set
	1	MT32-DEC4	Decoder for 4 channels, Output 4 x BNC
	1	AC/DC	AC/DC power supply for DEC4 (Optional)
			MT32-4CH-IND-TX-RX, 4xSTG, BATT, BW 4x0-12000Hz
	4	MT32-STG	Signal conditioning module for strain gages with digital data acquisition
	1	MT32-ENC8	Encoder for up to 8 acquisition module
	1	MT32-IND-RX-TX	Inductive telemetry 2560kbit transmitter and receiver (distance 0.1m)
	1	BATT-PACK	Battery pack
	1	BATT-SET	Battery set
	1	MT32-DEC4	Decoder for 4 channels, Output 4 x BNC
	1	AC/DC	AC/DC power supply for DEC4 (Optional)
			MT32-8CH-40k, 8xSTG, BATT, BW 8x0-95Hz
	8	MT32-STG	Signal conditioning module for strain gages with digital data acquisition
	1	MT32-ENC8	Encoder for up to 8 acquisition module
	1	MT32-40k-10	ISM-Band telemetry transmitter and receiver (distance up to 0.5 to 10m)
	1	BATT-PACK	Battery pack
	1	BATT-SET	Battery set
	1	MT32-DEC8	Decoder for 8 channels, Output 8 x BNC
	1	AC/DC	AC/DC power supply for DEC8 (Optional)

Item	Qty.	Type	Description
8b			Order Samples
			MT32-8CH-IND-TX-RX, 8xSTG, BATT, BW 8x0-6000Hz
8		MT32-STG	Signal conditioning module for strain gages with digital data acquisition
1		MT32-ENC8	Encoder for up to 8 acquisition module
1		MT32-IND-RX-TX	Inductive telemetry 2560kbit transmitter and receiver (distance 0.1m)
1		BATT-PACK	Battery pack
1		BATT-SET	Battery set
1		MT32-DEC8	Decoder for 8 channels. Output 8 x BNC
1		AC/DC	AC/DC power supply for DEC8 (Optional)
			MT32-8CH-IND-TX-RX, 8xSTG, BATT, BW 8x0-6000Hz, DIG-OUT only Digital OUT, with interface and software
8		MT32-STG	Signal conditioning module for strain gages with digital data acquisition
1		MT32-ENC8	Encoder for up to 8 acquisition module
1		MT32-IND-RX-TX	Inductive telemetry 2560kbit transmitter and receiver (distance 0.1m)
1		BATT-PACK	Battery pack
1		BATT-SET	Battery set
1		MT32-DEC-DIG	Decoder with only digital output for IF16 or ECIA100
1		ECIA100	Digital interface for notebook (IF16-PCMCIA)
1		MLab	32bit data acquisition and on-line processing software for WinXP/2000
1		MGraph	32bit data analysis software for WinXP/2000 (option)
1		AC/DC	AC/DC power supply for DEC-DIG (Optional)
			MT32-8CH-IND-TX-RX, 8xSTG, IND-PWR, BW 8x0-6000Hz
8		MT32-STG	Signal conditioning module for strain gages with digital data acquisition
1		MT32-ENC8	Encoder for up to 8 acquisition module
1		MT32-IND-RX-TX	Inductive telemetry 2560kbit transmitter and receiver (distance 0.1m)
1		IND-PWR-L	Inductive power supply
1		MT32-DEC8	Decoder for 8 channels, Output 8 x BNC
2		AC/DC	AC/DC power supply (1x for DEC8, 1x for IND-PWR)
			MT32-8CH-IND-TX-RX 6xSTG, 2 x ICP, BATT, BW 8x0-6000Hz
6		MT32-STG	Signal conditioning module for strain gages with digital data acquisition
2		MT32-ICP	Signal conditioning module for ICP sensors with digital data acquisition
1		MT32-ICP-Pwr	Power module for MT32-ICP
1		MT32-ENC8	Encoder for up to 8 acquisition module
1		MT32-IND-RX-TX	Inductive telemetry 2560kbit transmitter and receiver (distance 0.1m)
1		BATT-PACK	Battery pack
1		BATT-SET	Battery set
1		MT32-DEC8	Decoder for 8 channels, Output 8 x BNC
1		AC/DC	AC/DC power supply
			MT32-16CH-IND-TX-RX 16xSTG, BATT, BW 16x0-3000Hz
16		MT32-STG	Signal conditioning module for strain gages with digital data acquisition
1		MT32-ENC16	Encoder for up to 16 acquisition module
1		MT32-IND-RX-TX	Inductive telemetry 2560kbit transmitter and receiver (distance 0.1m)
1		DC/DC PWR-5V-500	Power modul for blue modules, IN 7-30V OUT 500mA 5VDC
1		MT32-DEC16	Decoder for 16 channels, Output via 37pol. Sub-D Connector
1		BNC16 BOX	Adapter BOX for DEC16 multiple 37pole Sub-D to 16 single BNC connectors
1		AC/DC	AC/DC power supply

Item	Qty.	Type	Description
8c			Order Samples
16	1	MT32-STG	MT32-16CH-IND-TX-RX 16xSTG, BATT, BW 16x0-3000Hz only Digital OUT, with interface and software Signal conditioning module for strain gages with digital data acquisition
1	1	MT32-ENC16	Encoder for up to 16 acquisition module
1	1	MT32-IND-RX-TX	Inductive telemetry 2560kbit transmitter and receiver (distance 0.1m)
1	1	DC/DC PWR-5V-500	Power modul for blue modules, IN 7-30V OUT 500mA 5VDC
1	1	MT32-DEC-DIG	Decoder with only digital output for IF16 or ECIA100
1	1	ECIA100	Digital interface for notebook (IF16-PCMCIA)
1	1	MLab	32bit data acquisition and on-line processing software for WinXP/2000
1	1	MGraph	32bit data analysis software for WinXP/2000 (option)
1	1	AC/DC	AC/DC power supply
16	1	MT32-STG	MT32-16CH-IND-TX-RX, 16xSTG, IND-PWR, BW 16x0-3000Hz Signal conditioning module for strain gages with digital data acquisition
1	1	MT32-ENC16	Encoder for up to 16 acquisition module
1	1	MT32-IND-RX-TX	Inductive telemetry 2560kbit transmitter and receiver (distance 0.1m)
1	1	IND-PWR-XL	Inductive power supply
1	1	MT32-DEC16	Decoder for 16 channels, Output via 37pol. Sub-D Connector
1	1	BNC16 BOX	Adapter BOX for DEC16 multiple 37pole Sub-D to 16 single BNC connectors
2	2	AC/DC	AC/DC power supply (1x for DEC16, 1x for IND-PWR)
16	1	MT32-STG	MT32-16CH-40k, 16xSTG, BATT, BW 16x0-47Hz Signal conditioning module for strain gages with digital data acquisition
1	1	MT32-ENC16	Encoder for up to 16 acquisition module
1	1	MT32-40k-10	ISM-Band telemetry transmitter and receiver (distance up to 0.5 to 10m)
1	1	DC/DC PWR-5V-500	Power modul for blue modules, IN 7-30V OUT 500mA 5VDC
1	1	MT32-DEC16	Decoder for 16 channels, Output via 37pol. Sub-D Connector
1	1	BNC16 BOX	Adapter BOX for DEC16 multiple 37pole Sub-D to 16 single BNC connectors
1	1	AC/DC	AC/DC power supply for DEC16 (Optional)
32	1	MT32-STG	MT32-32CH-IND-TX-RX, 32xSTG, BATT, BW 32x0-1500Hz Signal conditioning module for strain gages with digital data acquisition
1	1	MT32-ENC32	Encoder for up to 32 acquisition module
1	1	MT32-40k-10	ISM-Band telemetry transmitter and receiver (distance up to 0.5 to 10m)
1	1	DC/DC PWR-5V-1000	Power modul for blue modules, IN 7-18V OUT 1000mA 5VDC
1	1	MT32-DEC32	Decoder for 32 channels, Output via 37pol. Sub-D Connector
1	1	BNC32 BOX	Adapter BOX for DEC32 multiple 37pole SubD to 32 single BNC connectors
1	1	AC/DC	AC/DC power supply for DEC32 (Optional)
32	1	MT32-STG	MT32-32CH-IND-TX-RX, 32xSTG, IND-PWR, BW 32x0-1500Hz Signal conditioning module for strain gages with digital data acquisition
1	1	MT32-ENC32	Encoder for up to 32 acquisition module
1	1	MT32-IND-RX-TX	Inductive telemetry 2560kbit transmitter and receiver (distance 0.1m)
1	1	IND-PWR-XXL	Inductive power supply
1	1	MT32-DEC32	Decoder for 32 channels, Output via 37pol. Sub-D Connector
1	1	BNC32 BOX	Adapter BOX for DEC32 multiple 37pole SubD to 32 single BNC connectors
1	1	AC/DC	AC/DC power supply for DEC32 (Optional)